



Sensors for maximum process reliability

Level and pressure instrumentation
for food production processes

VEGA HOME
OF VALUES

PROCESS RELIABILITY FROM STORAGE TANK TO BOTTLING LINE

In the food industry, hygiene, speed and flexibility are decisive factors for efficient, reliable production. VEGA offers optimal measurement technology for level and pressure. To your advantage.

Optimal measurement technology

For over 60 years, VEGA has been involved in the measurement of challenging media under special process conditions. We're right at home in this field where high-quality materials, perfect design and high functionality are absolutely essential.

Their sensors measure level and pressure in tanks, containers and pipelines with exceptional accuracy and reliability. Of course they are always with approvals and certificates like those according to FDA, EC 1935/2004, EHEDG and 3-A.

Tailor-made solutions

As a specialist in level measurement, VEGA offers the entire spectrum of suitable measuring principles. Especially when it comes to radar level measurement, they have been setting technological milestones over and over again and remain the market leader. Their sensors are currently in use in well over 1,000,000 applications.

The measuring ranges of their pressure transmitters with metallic or ceramic measuring cells start at a few millibars, but can extend to pressures of up to 1,000 bar. VEGA are one of the few manufacturers who develop and produce their very own pressure measuring cells like the ceramic-capacitive CERTEC®.

About VEGA

VEGA is a global manufacturer of process instrumentation. Its product portfolio includes sensors for measurement of level, point level and pressure, as well as the devices and software for integrating them into process control systems.

Founded in the Black Forest in 1959, today they employ 2,100 people worldwide, over 1,000 of whom work at the headquarters in Schiltach. Each and every one of them works with great passion to find the best solution for the customer's application – across all industries.





Level sensors, pressure and point level switches for efficient automation

To remain competitive, manufacturers must optimize process cycles and reduce costs – without compromising product quality.

The answer to this challenge is automation. With the standardised communication protocol IO-Link, the new VEGA sensors can be integrated into an existing system quite easily. In addition, standardized process fittings and a uniform hygienic adapter system ensure maximum flexibility during installation.



The compact radar sensors VEGAPULS, pressure switches VEGABAR as well as capacitive level switches VEGAPOINT with IO-Link. An innovative coloured light ring ensures better visibility from all directions and from a distance.

Level, point level and pressure sensors for challenging measurement tasks

VEGA sensors are well equipped for the complex measuring tasks in process automation – whether they deal with viscous liquids or fine powders or abrasive bulk solids.

The tailor-made plics® sensors offer a fitting solution for every installation site. No matter whether the measurement takes place in a small vessel, or in a tank with agitators or heating coils. Thanks to their versatile connection options, they can easily be integrated into any process application.



Customized plics® sensors for any measuring task in the process – from bulk solids silo to bottling line.

EASY CLEANING – RELIABLE PROCESSES

To help ensure hygienic and stable food production processes, VEGA offers materials specially tailored to the strict requirements of the industry – with all necessary approvals and material properties according to FDA and EC 1935/2004. Hygienic sensor designs meet the requirements of EHEDG and 3-A Sanitary.

Expertly designed

The sensors are especially characterised by their flush process fittings and leak-proof, robust housings (IP69K). Even while operating they can be CIP-cleaned with almost any cleaning agent up to 2 hours at 150 °C.

Perfect cleanability

VEGA sensors have been specially developed for the needs of the food industry, which are fulfilled by well-protected seals, all-metal housings and process contacting surfaces with a finish < 0.3 µm.



Heating medium
supply line

Fast response time for reliable
pressure monitoring with
pressure sensor VEGABAR 28



Cleaning agent
storage tank

Reliable detection and long
service life with VEGASWING 61





All other approvals can be found at www.vega.com

Standardised hygienic adapters

The standardised connections of the hygienic adapters, which guarantee high system availability, can be selected as needed. Installing the adapters requires only minimal effort. This end-to-end concept allows simple integration and fast maintenance – it also reduces spare parts inventories and production downtime.



Solvent tank

High measurement accuracy for dependable stock levels with VEGAPULS 6X

Efficient CIP cleaning

During CIP cleaning, different liquids are pumped through the system piping one after the other. The cleaning media used are caustic and acidic solutions, some in high concentrations, and water, often at high temperatures.

VEGA sensors, which easily withstand the intensive CIP processes, ensure that all required liquids are available in sufficient quantities for each process step.

RELIABLE PROCESSES – CONSISTENT PRODUCT QUALITY

VEGA sensors deliver a convincing performance in applications that require a 100 % hygienic environment: They minimize maintenance and downtime while significantly increasing safety and efficiency.

High-quality materials withstand the aggressive cleaning agents: The hygienic design is totally free of gaps, pockets and dead spaces which, even during steam jet cleaning, avoids leakage.

Whether for square or cylindrical tanks, for a standalone measurement setup or integration into a system, for large or small vessels or vessels with agitators and heating elements: VEGA offers a comprehensive range of sensors for precise, safe measurement of foodstuffs.

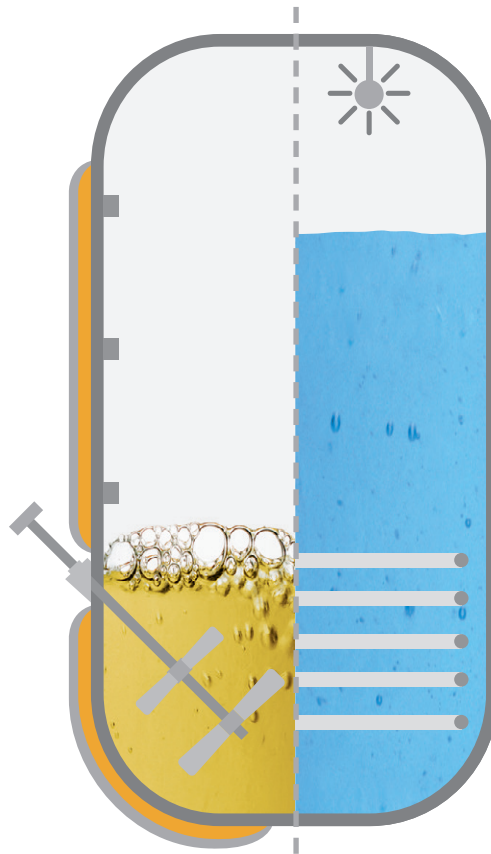

Food production in 3D

Example applications in breweries, dairies and tomato productions can be found at:

www.vega.com/food-industry



Agitator and spray ball

- Radar sensor VEGAPULS 6X for continuous level measurement
- Reliable measurement despite vessel internals and agitators thanks to highly focused radar beam

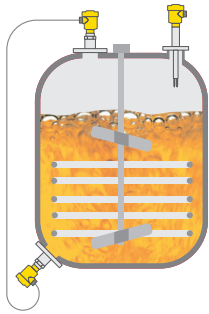

Heating coils

- Electronic differential pressure measurement with VEGABAR 83 for level measurement
- Reliable measurement of level and pressure, unaffected by heating coils
- Vibrating level switch VEGASWING 61 for point level detection
- Reliable overfill protection through product-independent switching point

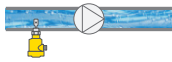

Dry-run protection for pumps

- Vibrating level switch VEGASWING 61 for point level detection
- Reliable function thanks to product-independent switching point



Storage tank for liquids

- Pressure sensor VEGABAR 83 for hydrostatic level measurement
- Robust measuring cell guarantees long-term stability



Bulk solids silo

- Radar sensor VEGAPULS 6X for continuous level measurement
- Trustworthy measurement, unaffected by dust and buildup
- Vibrating level switch VEGAWAVE 61 for point level detection
- Reliable detection, even in applications with light bulk solids

MAXIMUM SYSTEM AVAILABILITY

VEGA supports efficient processes with the right components: Sensors that detect even the smallest level or pressure changes and that can be installed very quickly with standard connections. M12 and valve plug connectors make a significant contribution to reducing the costs of automated processes to a reasonable level.

Flexibility with IO-Link

VEGA uses IO-Link to provide a uniform communication standard for fast and error-free connections to higher-level systems. It enables sensors to be monitored and commissioned very efficiently.

Wireless operation via smartphone

The integrated wireless function allows remote sensor setup and monitoring from a distance of up to 50 metres. All you need for this is: The VEGA Tools app and a smartphone or tablet.

Small yet highly visible

Thanks to the 360° switching status display, all switching states can be easily seen from any direction. The colour can be freely selected to suit your production facilities.

The proven VDMA menu structure with additional plain text display reduces the amount of training required.

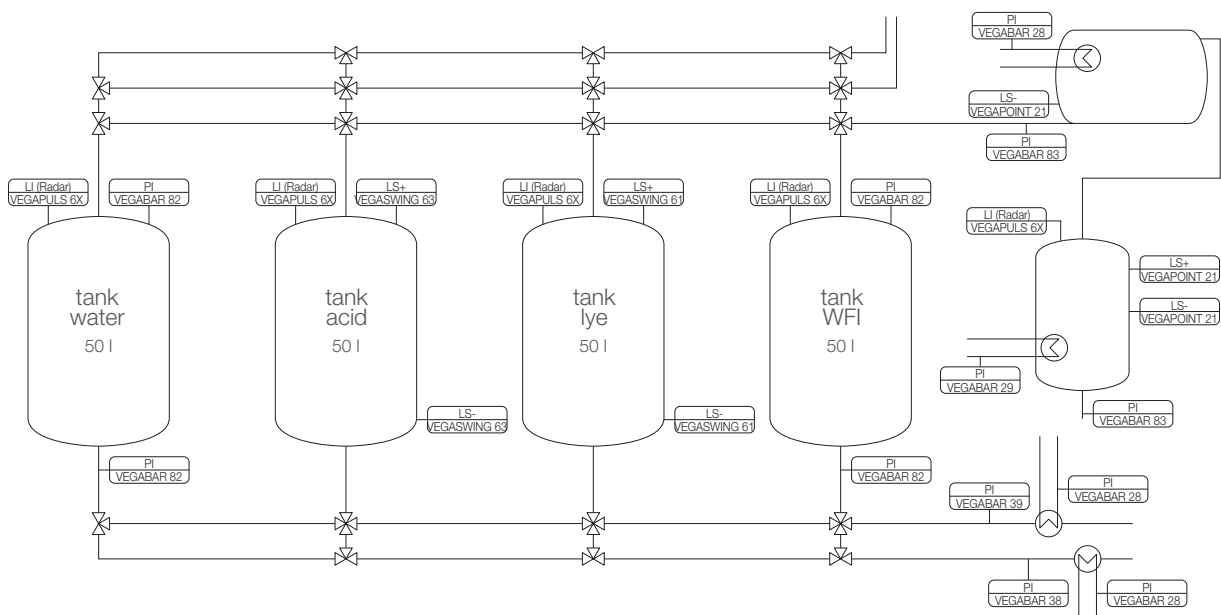

Schematic of a CIP system with level, pressure and point level sensors

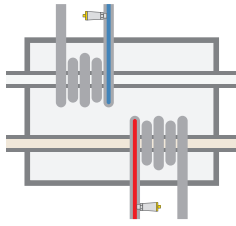

Cooling and heating system

- Pressure sensor VEGABAR 29 with metallic measuring cell and IO-Link connection
- Precise pressure measurement for an optimal heating or cooling process

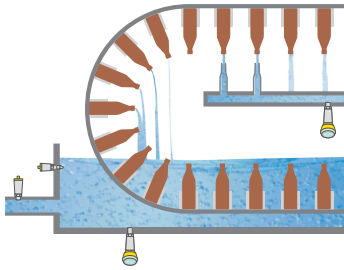

Bottle cleaning

- Capacitive level switch VEGAPOINT 21 for point level detection
- Pressure switch VEGABAR 28 with ceramic measuring cell and IO-Link connection
- Full-colour, 360° switching status display for easy recognition of switching status



Dry run protection

- Capacitive level switch VEGAPOINT 24 for point level detection
- Reliable level detection even under dusty conditions



Bottling tank

- Compact radar sensor VEGAPULS 42 for continuous level measurement
- Short reaction time for fast level changes, even in small vessels

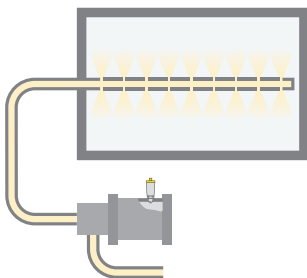

Hydraulic oil

- Pressure sensor VEGABAR 29 with IO-Link connection
- Pressure switch for optimal piston control

INTERCONNECTED SOLUTIONS

To ensure that production facilities are competitive today and stay competitive tomorrow, process cycles have to be optimized and costs reduced – without compromising quality. With intelligent networking and unique services, VEGA makes processes noticeably more efficient and reliable throughout the entire value-added chain in food production.

Wireless operation

With Bluetooth, VEGA is looking far into the future. But even today, radio technology is already making processes more and more flexible. Wireless communication provides better accessibility: In clean rooms, in harsh industrial environments and in hazardous areas. It allows setup, display and diagnostics from a distance of up to 50 metres, thus saving time and avoiding hazardous situations. Simply via VEGA Tools app – on any available smartphone or tablet.

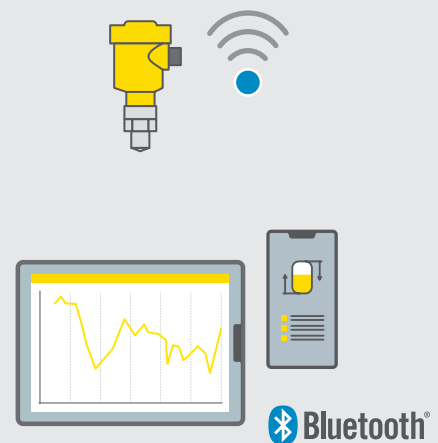

IO-Link

VEGA uses IO-Link to make optimal use of all possibilities in the food industry. With this manufacturer-independent, standard communication tool, sensors can be installed, parameterised and, if necessary, put back into operation faster and more cost-effectively. IO-Link is a digital interface that automatically re-commissions sensors if they are replaced.



myVEGA

In myVEGA, your personal customer portal, numerous online functions relating to VEGA products are available to you.

The advantages of myVEGA

- Generate exact drawings of your instruments
- Get the current prices and delivery times quickly
- Request a quotation specifically tailored to your needs
- Order the products you want directly online
- Find all important order and instrument documents quickly
- Track the status of your order
- Save your instrument settings and documentation in the VEGA Cloud

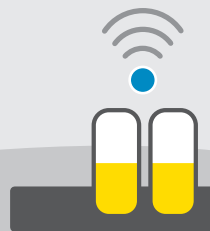
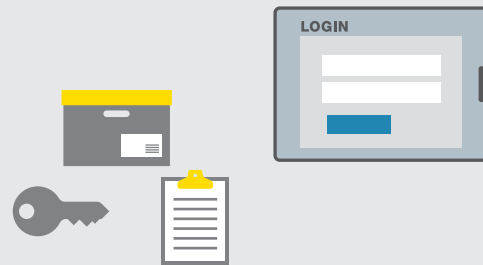

VEGA Inventory System

Optimal inventory levels mean lower costs. VEGA Inventory System makes all important process and forecast information visible and easy to grasp. Measuring instruments installed on containers, tanks or silos automatically inform the user when replenishments are required. In your plant, the user-friendly service software accesses not only the current measurement and predicted usage information, but also historical consumption data.

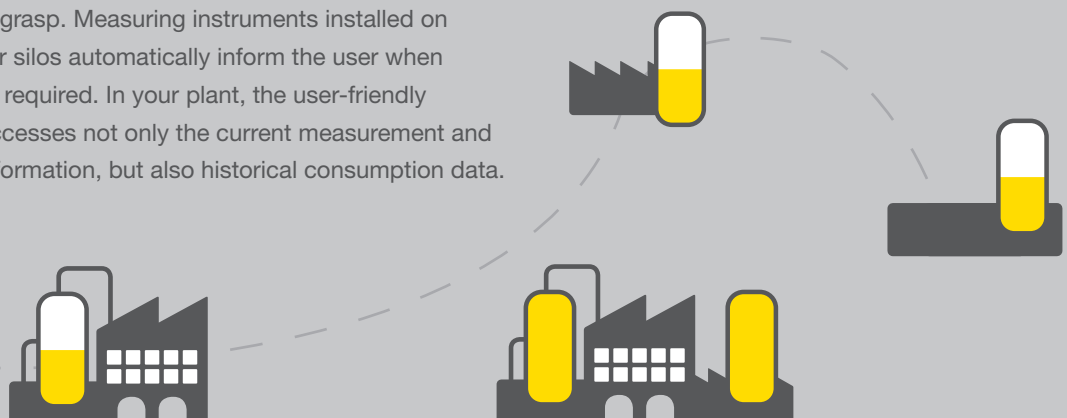

LEVEL MEASUREMENT

PRO

VEGAPULS 6X



BASIC

VEGAPULS 42



PRO

VEGAFLEX 83



Sensor	80 GHz radar sensor	80 GHz radar sensor	GWR sensor
Application	Liquids and bulk solids for all process conditions	Liquids and bulk solids at simple to moderate process conditions	Aggressive liquids or liquid media with stringent hygienic requirements, applications with steam, buildup, foam generation or condensation
Measuring range	up to 120 m	up to 15 m	Cable probe up to 32 m of PFA Rod probe up to 4 m of PFA or 1.4435 (BN)
Antenna	Integrated antenna, horn antenna, lens antenna, parabolic antenna	Integrated antenna	-
Version	-	-	Cable (ø 4 mm) Rod (ø 8 mm, ø 10 mm)
Process fitting	Thread from G $\frac{3}{4}$ ", flanges from DN20/ $\frac{3}{4}$ ", hygienic fittings	Thread G $\frac{3}{4}$ ", $\frac{1}{2}$ NPT", thread G1", 1" NPT, thread G1" for hygienic fittings	Flanges from DN 25, 1", hygienic fittings, clamp, slotted nut
Process temperature	-196 ... +450 °C	-40 ... +130 °C 15 min. @ +150 °C steam	-40 ... +150 °C
Process pressure	-1 ... +160 bar (-100 ... +16000 kPa)	-1 ... +16 bar (-100 ... +1600 kPa)	-1 ... +16 bar (-100 ... +1600 kPa)
Accuracy	±1 mm	±2 mm	±2 mm
Frequency range	W-band (80 GHz), C-band (6 GHz), K-band (26 GHz)	W-Band (80 GHz)	-
Signal output	4 ... 20 mA/HART, APL, Profibus PA, Foundation Fieldbus, Modbus	Three-wire: PNP/NPN, 4 ... 20 mA, IO-Link	4 ... 20 mA/HART, Profibus PA, Foundation Fieldbus, Modbus
Display/adjustment	PLICSCOM, PACTware/DTM, VEGADIS 81, VEGADIS 82, VEGA Tools app	PACTware/DTM, VEGA Tools app, IODD, Bluetooth, full-colour multi- directional switching status indication	PLICSCOM, PACTware/DTM, VEGADIS 81, VEGADIS 82, VEGA Tools app
Approvals	ATEX, UKEX, IECEx, FM, CSA, NEPSI, EAC (GOST), INMETRO, TIIS, KOSHA/KTL, CCOE, UKR Sepro, Overfill protection, Ship, SIL2/3, food	3A, EHEDG, FDA, FM, CSA	ATEX, UKEX, IECEx, FM, CSA, EAC (GOST), UKR Sepro, Overfill protection, Ship, SIL2, EHEDG, 3-A, FDA, INMETRO, NEPSI, KOSHA, CCOE
Benefit	✓ Universal use through different antenna versions	✓ Easy integration into control systems through IO-Link communication	✓ Gap-free hygienic design ensures good cleanability with simple methods

PRESSURE MEASUREMENT

PRO

VEGABAR 81



PRO

VEGABAR 82



PRO

VEGABAR 83



Sensor	Pressure transmitter	Pressure transmitter	Pressure transmitter
Application	Liquids and gases with high temperatures	Liquids and gases	Liquids and gases also with high pressures
Deviation	0.1 %	0.2 %; 0.1 %; 0.05 %	0.2 %; 0.1 %; 0.075 %
Measuring cell	Chemical seal system	CERTEC®, MINI-CERTEC®	Piezoresistive/thin film strain gauge/METEC®
Measuring cell seal	–	FKM, EPDM, FFKM	–
Process fitting	Thread from G½, ½ NPT, flanges from DN 25, 1", hygienic fittings of 316L, Alloy, Duplex, Tantalum, gold	Thread from G½, ½ NPT, flanges from DN 15, ½", hygienic fittings; 316L, Alloy, Duplex, PVDF, PEEK	Thread from G¼, ¼ NPT, flanges from DN 25, 1", hygienic fittings; 316L, Alloy
Process temperature	-90 ... +400 °C	-40 ... +150 °C	-40 ... +200 °C
Measuring range	Absolute and relative -1 ... +1000 bar (-100 ... +100000 kPa)	Absolute and relative -1 ... +100 bar (-100 ... +10000 kPa)	Absolute and relative -1 ... +1000 bar (-100 ... +100000 kPa)
Overload resistance	Depending on chemical seal system	up to 200-fold measuring range	up to 150-fold measuring range
Signal output	4 ... 20 mA, 4 ... 20 mA/HART, Profibus PA, Foundation Fieldbus, Modbus	4 ... 20 mA, 4 ... 20 mA/HART, Profibus PA, Foundation Fieldbus, Modbus	4 ... 20 mA, 4 ... 20 mA/HART, Profibus PA, Foundation Fieldbus, Modbus
Display/adjustment	PLICSCOM, PACTware/DTM, VEGADIS 81, VEGADIS 82, VEGA Tools app	PLICSCOM, PACTware/DTM, VEGADIS 81, VEGADIS 82, VEGA Tools app	PLICSCOM, PACTware/DTM, VEGADIS 81, VEGADIS 82, VEGA Tools app
Approvals	ATEX, UKEX, IECEx, FM, CSA, NEPSI, EAC (GOST), INMETRO, CCOE, SEPRO, Overfill protection, Ship, SIL2/3, CE 1935/2004, FDA	ATEX, UKEX, IECEx, FM, CSA, NEPSI, EAC (GOST), INMETRO, CCOE, SEPRO, Overfill protection, Ship, SIL2/3, CE 1935/2004, FDA, 3-A	ATEX, UKEX, IECEx, FM, CSA, NEPSI, EAC (GOST), INMETRO, CCOE, SEPRO, Overfill protection, Ship, SIL2/3, CE 1935/2004, FDA, 3-A, EHEDG
Benefit	✓ Optimal process adaptation through selection of various wetted materials, media and temperature couplers	✓ High resistance to abrasion and corrosion through use of high-quality Sapphire Ceramic®	✓ Reliable measurement even at high pressures

PRESSURE MEASUREMENT

BASIC

VEGABAR 18



BASIC

VEGABAR 19



BASIC

VEGABAR 28



Sensor	Pressure sensor	Pressure sensor	Pressure sensor with switching
Application	Liquids and gases	Liquids and gases, even at high pressure	Liquids and gases
Deviation	0.5 %	0.5 %	0.3 %
Measuring cell Measuring cell seal	Ceramic measuring cell FKM	Metallic measuring cell –	Ceramic measuring cell FKM, EPDM, FFKM
Process fitting	½" standard thread, 316L	½", 1", standard thread, optional front-flush; 316L	Thread, optionally with front-flush and hygienic fittings, universal connection for hygienic adapter; 316L, Duplex, PEEK
Process temperature	-40 ... +100 °C	-40 ... +100 °C	-40 ... +130 °C/ 1 h @ +135 °C steam
Measuring range	Relative 0 ... +25 bar (0 ... +2500 kPa)	Relative 0 ... +100 bar (0 ... +10000 kPa)	Absolute and relative -1 ... +60 bar (-100 ... +6000 kPa)
Overload resistance	Up to 150-fold measuring range	Up to 4-fold measuring range	up to 150-fold measuring range
Signal output	Two-wire: 4 ... 20 mA	Two-wire: 4 ... 20 mA	Two-wire: 4 ... 20 mA Three-wire: PNP/NPN, 4 ... 20 mA, IO-Link
Display/adjustment	–	–	PACTware/DTM, VEGA Tools app, IODD, Bluetooth, full-colour multidirectional switching status indication
Approvals	–	–	ATEX, UKEX, IECEx, cULus, NEPSI, EAC, INMETRO, IA, CCOE, TIIS, KOSHA/KTL, SEPRO, CE 1935/2004, FDA, China FDA, Ship
Benefit	✓ Low-cost version with extremely small installation dimensions	✓ Universally applicable due to fully welded metallic measuring cell construction	✓ Highly visible, adjustable full-colour multidirectional (360°) switch status indication

BASIC

VEGABAR 29



Pressure sensor with switching

Liquids and gases, even at high pressure

0.3 %

Metallic measuring cell
–

Optional front-flush thread and hygienic fittings, universal connector for hygiene adapter; 316L

-40 ... +130 °C/
1 h @ +135 °C steam

Absolute and relative
-1 ... +1000 bar
(-100 ... +100000 kPa)

up to 4-fold measuring range

Two-wire: 4 ... 20 mA
Three-wire: PNP/NPN,
4 ... 20 mA, IO-Link

PACTware/DTM,
VEGA Tools app, IODD, Bluetooth,
full-colour multidirectional
switching status indication

ATEX, UKEX, IECEx, cULus,
NEPSI, EAC, INMETRO, IA,
CCOE, TIIS, KOSHA/KTL, SEPRO,
CE 1935/2004, FDA, 3-A, EHEDG,
China FDA, Ship

✓ Simple integration into control systems through IO-Link communication

BASIC

VEGABAR 38



Pressure sensor with switching

Liquids and gases

0.3 %

Ceramic measuring cell
FKM, EPDM, FFKM

Optional front-flush thread and hygienic fittings, universal connector for hygiene adapter; 316L, Duplex, PEEK

-40 ... +130 °C/
1 h @ +135 °C steam

Absolute and relative
-1 ... +60 bar
(-100 ... +6000 kPa)

up to 150-fold measuring range

Two-wire: 4 ... 20 mA
Three-wire: PNP/NPN,
4 ... 20 mA, IO-Link

Integrated on-site display and 3-key operation, PACTware/DTM, VEGA Tools app, IODD, Bluetooth, full-colour multidirectional switching status indication

ATEX, UKEX, IECEx, cULus,
NEPSI, EAC, INMETRO, IA,
CCOE, TIIS, KOSHA/KTL, SEPRO,
CE 1935/2004, FDA, China FDA,
Ship

✓ Simple setup thanks to large on-site display with VDMA operation and additional texts

BASIC

VEGABAR 39



Pressure sensor with switching

Liquids and gases, even at high pressure

0.3 %

Metallic measuring cell
–

Optional front-flush thread and hygienic fittings, universal connector for hygiene adapter; 316L

-40 ... +130 °C/
1 h @ +135 °C steam

Absolute and relative
-1 ... +1000 bar
(-100 ... +100000 kPa)

up to 4-fold measuring range

Two-wire: 4 ... 20 mA
Three-wire: PNP/NPN,
4 ... 20 mA, IO-Link

Integrated on-site display and 3-key operation, VEGA Tools app, IODD, Bluetooth, full-colour multidirectional switching status indication

ATEX, UKEX, IECEx, cULus, NEPSI,
EAC, INMETRO, IA, CCOE, TIIS,
KOSHA/KTL, SEPRO, CE 1935/2004,
FDA, 3-A, EHEDG, China FDA, Ship

✓ Simple setup thanks to large on-site display with VDMA operation and additional texts

POINT LEVEL DETECTION for liquids

BASIC

VEGASWING 51/53



PRO

VEGASWING 61/63



BASIC

VEGAPOINT 11



Sensor	Vibrating level switch	Vibrating level switch	Capacitive level switch
Application	Liquids	Liquids	Water-based liquids
Version	VEGASWING 51: Compact version VEGASWING 53: Tube extension up to 1 m	VEGASWING 61: Compact version VEGASWING 63: Tube extension up to 6 m	Compact version of 316L, PEEK
Measuring range	–	–	–
Material	316L	316L, ECTFE, PFA, enamel, Alloy 400, Duplex, Alloy C22	–
Process fitting	Thread from G $\frac{1}{2}$, $\frac{1}{2}$ NPT, hygienic fittings	Thread from G $\frac{3}{4}$, $\frac{3}{4}$ NPT, flanges from DN 25, 1", hygienic fittings	Threads from G $\frac{1}{2}$, $\frac{1}{2}$ NPT, universal connector for hygiene adapter
Process temperature	-40 ... +150 °C	-50 ... +250 °C	-20 °C ... +100 °C/ 1 h @ +135 °C
Process pressure	-1 ... +64 bar (-100 ... +6400 kPa)	-1 ... +64 bar (-100 ... +6400 kPa)	-1 ... +25 bar (-100 ... +2500 kPa)
Signal output	Transistor output, contactless electronic switch, IO-Link	Relay, transistor, two-wire, NAMUR output, contactless electronic switch	Three-wire: PNP/NPN, IO-Link
Display	Control lamp (LED)	Control lamp (LED) or pluggable display module PLICSLED	LED
Approvals	VEGASWING 51: Overfill protection, Ship, CSA-OL, EHEDG, FDA, CE 1935/2004, EAC (GOST) VEGASWING 53: Overfill protection, CSA-OL, EHEDG, FDA, CE 1935/2004	ATEX, UKEX, IECEx, FM, CSA, EAC (GOST), UKR Sepro, Overfill protection, Ship, SIL2, KOSHA, NEPSI, INMETRO	CE 1935/2004, FDA, ADI
Benefit	✓ Minimal time and cost expenditure thanks to simple setup without medium		✓ Adjustment-free for easy setup

BASIC

VEGAPOINT 21



Capacitive level switch

liquids

Compact version of 316L, PEEK

-

-

Threads from G½, ½ NPT, universal connector for hygiene adapter

-40 °C ... +115 °C/
1 h @ +135 °C

-1 ... +64 bar
(-100 ... +6400 kPa)

Three-wire: PNP/NPN, IO-Link, Bluetooth

Full-colour multidirectional switching status indication

ATEX, UKEX, IECEx, CE 1935/2004, FDA, 3-A, EHEDG, ASME BPE, USP Class VI, ADI, China FDA, WHG, VLAREM, SVTI, Ship

✓ Highly visible, adjustable full-colour multidirectional (360°) switching status display

BASIC

VEGAPOINT 23



Capacitive level switch

Liquids and bulk solids

Compact version of 316L, PEEK with tube extension up to 1 m

-

-

Thread from G½, ½ NPT, universal connector for hygiene adapter

Tube extension ≤ 250 mm:
-40 °C ... +115 °C/1 h @ +135 °C
Tube extension > 250 mm:
-40 °C ... +80 °C/1 h @ +135 °C

-1 ... +64 bar
(-100 ... +6400 kPa)

Three-wire: PNP/NPN, IO-Link, Bluetooth

Full-colour multidirectional switching status indication

ATEX, UKEX, IECEx, CE 1935/2004, FDA, 3-A, EHEDG, ASME BPE, USP Class VI, ADI, China FDA, WHG, VLAREM, SVTI, Ship

✓ Low-cost level switch with selectable switching point position/tube extension

BASIC

VEGAPOINT 24



Capacitive level switch

Adhesive media or front flush mounting

Compact version of 316L, PEEK

-

-

Thread from G½, ½ NPT, universal connector for hygiene adapter

-40 °C ... +115 °C/1 h @ +135 °C

-1 ... +64 bar
(-100 ... +6400 kPa)

Three-wire: PNP/NPN, IO-Link, Bluetooth

Full-colour multidirectional switching status indication

ATEX, UKEX, CE 1935/2004, FDA, 3-A, EHEDG, USP Class VI, ADI, China FDA, WHG, VLAREM, SVTI

✓ Optimised for adhesive media via front-flush installation

POINT LEVEL DETECTION for bulk solids

BASIC

VEGAPOINT 31



PRO

VEGAWAVE 61/63



Sensor	Capacitive level switch	Vibrating level switch
Application	bulk solids	Powders and fine-grained bulk solids
Version	Compact version of 316L, PEEK	VEGAWAVE 61: Compact version VEGAWAVE 63: Tube extension up to 6 m
Measuring range	–	Bulk solids from 8 g/l
Material	–	316L, CarboCer coating
Process fitting	Threads from G1½, ½ NPT, universal connector for hygiene adapter	Thread G1½, 1½ NPT, flanges from DN 50, 2", hygienic fittings
Process temperature	-40 °C ... +115 °C/ 1 h @ +135 °C	-50 ... +250 °C
Process pressure	-1 ... +64 bar (-100 ... +6400 kPa)	-1 ... +25 bar (-100 ... +2500 kPa)
Signal output	Three-wire: PNP/NPN, IO-Link, Bluetooth	Relay, transistor, two-wire, NAMUR output, contactless electronic switch
Display	Full-colour multidirectional switching status indication	Control lamp (LED) or pluggable display module PLICSLED
Approvals	ATEX, UKEX, IECEx, CE 1935/2004, FDA, 3-A, EHEDG, ASME BPE, USP Class VI, ADI, China FDA, WHG, VLAREM, SVTI, Ship	ATEX, UKEX, IECEx, FM, CSA, EAC (GOST), UKR Sepro, SIL2, NEPSI, KOSHA/KTL, CCOE
Benefit	✓ Highly visible, adjustable full-colour multidirectional (360°) switching status display	✓ Minimal time and cost expenditure thanks to simple setup without medium

HYGIENIC ADAPTERS FOR LEVEL, PRESSURE AND POINT LEVEL SENSORS



Metallic sealing



Elastomer O-ring

Any common adapter system that complies with EC 1935/2004, FDA, EHEDG or 3-A can be used for level sensors as well as for pressure and point level sensors.

Whether with metal or with O-ring seal: The sensors fit all standard, commercially available hygienic connections.

- Flexible and simple integration
- Fast exchange
- Reduced production downtime
- Fewer instrument versions in stock
- Standardized hygienic adapter system for level, pressure and point level sensors



Level switch
VEGAPOINT series 10, 20, 30
G½", G1"



Level sensor
VEGAPULS 42
G1"



Level switch
VEGASWING series 50
G1"



Pressure transmitter
VEGABAR series 20 and 30
G1"



Fitting for G½"
Varivent N DN 40



Clamp liner DN 40
(DIN 11864-3)



Clamp
1-½"



Varivent F
DN 25



Collar connector
DN 40

Further hygienic fittings available.

OUR SERVICE FOR YOU!

From initial planning to setup or installation advice – we are here for you. Would you like to talk with one of our experts and work out together which sensor best suits your needs? Just get in touch! We're always happy to help and advise, so you can select the right instrument for the job!

Training with added value

Our seminars are designed to deliver our technical knowledge and experience to you in the most effective way possible. We can host training sessions at our facilities or come to your location.

24-hour service hotline

You can reach our technical support anytime there's an emergency – 24 hours a day.

Delivery with SPEED

Because time is money, we have a delivery concept called "SPEED". It ensures that our sensors are delivered to you within a few days.

CONSULTATION

Would you like to receive expert consultation?
Just give us a call.

Consultation on products and applications

Mon–Fri from 8:00 AM to 4:00 PM

+49 7836 50-0

ONLINE

Find the full range of our solutions quickly and conveniently online. User-friendly search functions guide you to the right product with just a few clicks.

www.vega.com/food-industry